

ORDER OF PLANS	PLATE NO.
COVER SHEET	1
GENERAL INFORMATION	2
CUTBOARD PROFILE	3
INBOARD PROFILE	4
DECK LEVEL ABOVE	5
1 <sup>ST</sup> LEVEL	6
2 <sup>ND</sup> LEVEL	7
3 <sup>RD</sup> LEVEL	8
4 <sup>TH</sup> LEVEL	9
5 <sup>TH</sup> LEVEL	10
6 <sup>TH</sup> LEVEL	11
7 <sup>TH</sup> LEVEL	12
8 <sup>TH</sup> LEVEL	13
9 <sup>TH</sup> LEVEL	14
10 <sup>TH</sup> LEVEL	15
11 <sup>TH</sup> LEVEL	16
12 <sup>TH</sup> LEVEL	17
13 <sup>TH</sup> LEVEL	18
14 <sup>TH</sup> LEVEL	19
15 <sup>TH</sup> LEVEL	20
16 <sup>TH</sup> LEVEL	21
17 <sup>TH</sup> LEVEL	22
18 <sup>TH</sup> LEVEL	23
19 <sup>TH</sup> LEVEL	24
20 <sup>TH</sup> LEVEL	25
21 <sup>ST</sup> LEVEL	26
22 <sup>ND</sup> LEVEL	27
23 <sup>RD</sup> LEVEL	28
24 <sup>TH</sup> LEVEL	29
25 <sup>TH</sup> LEVEL	30
26 <sup>TH</sup> LEVEL	31
27 <sup>TH</sup> LEVEL	32
28 <sup>TH</sup> LEVEL	33
29 <sup>TH</sup> LEVEL	34
30 <sup>TH</sup> LEVEL	35
31 <sup>ST</sup> LEVEL	36
32 <sup>ND</sup> LEVEL	37
33 <sup>RD</sup> LEVEL	38
34 <sup>TH</sup> LEVEL	39
35 <sup>TH</sup> LEVEL	40
36 <sup>TH</sup> LEVEL	41
37 <sup>TH</sup> LEVEL	42
38 <sup>TH</sup> LEVEL	43
39 <sup>TH</sup> LEVEL	44
40 <sup>TH</sup> LEVEL	45
41 <sup>ST</sup> LEVEL	46
42 <sup>ND</sup> LEVEL	47
43 <sup>RD</sup> LEVEL	48
44 <sup>TH</sup> LEVEL	49
45 <sup>TH</sup> LEVEL	50
46 <sup>TH</sup> LEVEL	51
47 <sup>TH</sup> LEVEL	52
48 <sup>TH</sup> LEVEL	53
49 <sup>TH</sup> LEVEL	54
50 <sup>TH</sup> LEVEL	55
51 <sup>ST</sup> LEVEL	56
52 <sup>ND</sup> LEVEL	57
53 <sup>RD</sup> LEVEL	58
54 <sup>TH</sup> LEVEL	59
55 <sup>TH</sup> LEVEL	60
56 <sup>TH</sup> LEVEL	61
57 <sup>TH</sup> LEVEL	62
58 <sup>TH</sup> LEVEL	63
59 <sup>TH</sup> LEVEL	64
60 <sup>TH</sup> LEVEL	65
61 <sup>ST</sup> LEVEL	66
62 <sup>ND</sup> LEVEL	67
63 <sup>RD</sup> LEVEL	68
64 <sup>TH</sup> LEVEL	69
65 <sup>TH</sup> LEVEL	70
66 <sup>TH</sup> LEVEL	71
67 <sup>TH</sup> LEVEL	72
68 <sup>TH</sup> LEVEL	73
69 <sup>TH</sup> LEVEL	74
70 <sup>TH</sup> LEVEL	75
71 <sup>ST</sup> LEVEL	76
72 <sup>ND</sup> LEVEL	77
73 <sup>RD</sup> LEVEL	78
74 <sup>TH</sup> LEVEL	79
75 <sup>TH</sup> LEVEL	80
76 <sup>TH</sup> LEVEL	81
77 <sup>TH</sup> LEVEL	82
78 <sup>TH</sup> LEVEL	83
79 <sup>TH</sup> LEVEL	84
80 <sup>TH</sup> LEVEL	85
81 <sup>ST</sup> LEVEL	86
82 <sup>ND</sup> LEVEL	87
83 <sup>RD</sup> LEVEL	88
84 <sup>TH</sup> LEVEL	89
85 <sup>TH</sup> LEVEL	90
86 <sup>TH</sup> LEVEL	91
87 <sup>TH</sup> LEVEL	92
88 <sup>TH</sup> LEVEL	93
89 <sup>TH</sup> LEVEL	94
90 <sup>TH</sup> LEVEL	95
91 <sup>ST</sup> LEVEL	96
92 <sup>ND</sup> LEVEL	97
93 <sup>RD</sup> LEVEL	98
94 <sup>TH</sup> LEVEL	99
95 <sup>TH</sup> LEVEL	100
96 <sup>TH</sup> LEVEL	101
97 <sup>TH</sup> LEVEL	102
98 <sup>TH</sup> LEVEL	103
99 <sup>TH</sup> LEVEL	104
100 <sup>TH</sup> LEVEL	105
101 <sup>ST</sup> LEVEL	106
102 <sup>ND</sup> LEVEL	107
103 <sup>RD</sup> LEVEL	108
104 <sup>TH</sup> LEVEL	109
105 <sup>TH</sup> LEVEL	110
106 <sup>TH</sup> LEVEL	111
107 <sup>TH</sup> LEVEL	112
108 <sup>TH</sup> LEVEL	113
109 <sup>TH</sup> LEVEL	114
110 <sup>TH</sup> LEVEL	115
111 <sup>ST</sup> LEVEL	116
112 <sup>ND</sup> LEVEL	117
113 <sup>RD</sup> LEVEL	118
114 <sup>TH</sup> LEVEL	119
115 <sup>TH</sup> LEVEL	120
116 <sup>TH</sup> LEVEL	121
117 <sup>TH</sup> LEVEL	122
118 <sup>TH</sup> LEVEL	123
119 <sup>TH</sup> LEVEL	124
120 <sup>TH</sup> LEVEL	125
121 <sup>ST</sup> LEVEL	126
122 <sup>ND</sup> LEVEL	127
123 <sup>RD</sup> LEVEL	128
124 <sup>TH</sup> LEVEL	129
125 <sup>TH</sup> LEVEL	130
126 <sup>TH</sup> LEVEL	131
127 <sup>TH</sup> LEVEL	132
128 <sup>TH</sup> LEVEL	133
129 <sup>TH</sup> LEVEL	134
130 <sup>TH</sup> LEVEL	135
131 <sup>ST</sup> LEVEL	136
132 <sup>ND</sup> LEVEL	137
133 <sup>RD</sup> LEVEL	138
134 <sup>TH</sup> LEVEL	139
135 <sup>TH</sup> LEVEL	140
136 <sup>TH</sup> LEVEL	141
137 <sup>TH</sup> LEVEL	142
138 <sup>TH</sup> LEVEL	143
139 <sup>TH</sup> LEVEL	144
140 <sup>TH</sup> LEVEL	145
141 <sup>ST</sup> LEVEL	146
142 <sup>ND</sup> LEVEL	147
143 <sup>RD</sup> LEVEL	148
144 <sup>TH</sup> LEVEL	149
145 <sup>TH</sup> LEVEL	150
146 <sup>TH</sup> LEVEL	151
147 <sup>TH</sup> LEVEL	152
148 <sup>TH</sup> LEVEL	153
149 <sup>TH</sup> LEVEL	154
150 <sup>TH</sup> LEVEL	155
151 <sup>ST</sup> LEVEL	156
152 <sup>ND</sup> LEVEL	157
153 <sup>RD</sup> LEVEL	158
154 <sup>TH</sup> LEVEL	159
155 <sup>TH</sup> LEVEL	160
156 <sup>TH</sup> LEVEL	161
157 <sup>TH</sup> LEVEL	162
158 <sup>TH</sup> LEVEL	163
159 <sup>TH</sup> LEVEL	164
160 <sup>TH</sup> LEVEL	165
161 <sup>ST</sup> LEVEL	166
162 <sup>ND</sup> LEVEL	167
163 <sup>RD</sup> LEVEL	168
164 <sup>TH</sup> LEVEL	169
165 <sup>TH</sup> LEVEL	170
166 <sup>TH</sup> LEVEL	171
167 <sup>TH</sup> LEVEL	172
168 <sup>TH</sup> LEVEL	173
169 <sup>TH</sup> LEVEL	174
170 <sup>TH</sup> LEVEL	175
171 <sup>ST</sup> LEVEL	176
172 <sup>ND</sup> LEVEL	177
173 <sup>RD</sup> LEVEL	178
174 <sup>TH</sup> LEVEL	179
175 <sup>TH</sup> LEVEL	180
176 <sup>TH</sup> LEVEL	181
177 <sup>TH</sup> LEVEL	182
178 <sup>TH</sup> LEVEL	183
179 <sup>TH</sup> LEVEL	184
180 <sup>TH</sup> LEVEL	185
181 <sup>ST</sup> LEVEL	186
182 <sup>ND</sup> LEVEL	187
183 <sup>RD</sup> LEVEL	188
184 <sup>TH</sup> LEVEL	189
185 <sup>TH</sup> LEVEL	190
186 <sup>TH</sup> LEVEL	191
187 <sup>TH</sup> LEVEL	192
188 <sup>TH</sup> LEVEL	193
189 <sup>TH</sup> LEVEL	194
190 <sup>TH</sup> LEVEL	195
191 <sup>ST</sup> LEVEL	196
192 <sup>ND</sup> LEVEL	197
193 <sup>RD</sup> LEVEL	198
194 <sup>TH</sup> LEVEL	199
195 <sup>TH</sup> LEVEL	200
196 <sup>TH</sup> LEVEL	201
197 <sup>TH</sup> LEVEL	202
198 <sup>TH</sup> LEVEL	203
199 <sup>TH</sup> LEVEL	204
200 <sup>TH</sup> LEVEL	205
201 <sup>ST</sup> LEVEL	206
202 <sup>ND</sup> LEVEL	207
203 <sup>RD</sup> LEVEL	208
204 <sup>TH</sup> LEVEL	209
205 <sup>TH</sup> LEVEL	210
206 <sup>TH</sup> LEVEL	211
207 <sup>TH</sup> LEVEL	212
208 <sup>TH</sup> LEVEL	213
209 <sup>TH</sup> LEVEL	214
210 <sup>TH</sup> LEVEL	215
211 <sup>ST</sup> LEVEL	216
212 <sup>ND</sup> LEVEL	217
213 <sup>RD</sup> LEVEL	218
214 <sup>TH</sup> LEVEL	219
215 <sup>TH</sup> LEVEL	220
216 <sup>TH</sup> LEVEL	221
217 <sup>TH</sup> LEVEL	222
218 <sup>TH</sup> LEVEL	223
219 <sup>TH</sup> LEVEL	224
220 <sup>TH</sup> LEVEL	225
221 <sup>ST</sup> LEVEL	226
222 <sup>ND</sup> LEVEL	227
223 <sup>RD</sup> LEVEL	228
224 <sup>TH</sup> LEVEL	229
225 <sup>TH</sup> LEVEL	230
226 <sup>TH</sup> LEVEL	231
227 <sup>TH</sup> LEVEL	232
228 <sup>TH</sup> LEVEL	233
229 <sup>TH</sup> LEVEL	234
230 <sup>TH</sup> LEVEL	235
231 <sup>ST</sup> LEVEL	236
232 <sup>ND</sup> LEVEL	237
233 <sup>RD</sup> LEVEL	238
234 <sup>TH</sup> LEVEL	239
235 <sup>TH</sup> LEVEL	240
236 <sup>TH</sup> LEVEL	241
237 <sup>TH</sup> LEVEL	242
238 <sup>TH</sup> LEVEL	243
239 <sup>TH</sup> LEVEL	244
240 <sup>TH</sup> LEVEL	245
241 <sup>ST</sup> LEVEL	246
242 <sup>ND</sup> LEVEL	247
243 <sup>RD</sup> LEVEL	248
244 <sup>TH</sup> LEVEL	249
245 <sup>TH</sup> LEVEL	250
246 <sup>TH</sup> LEVEL	251
247 <sup>TH</sup> LEVEL	252
248 <sup>TH</sup> LEVEL	253
249 <sup>TH</sup> LEVEL	254
250 <sup>TH</sup> LEVEL	255
251 <sup>ST</sup> LEVEL	256
252 <sup>ND</sup> LEVEL	257
253 <sup>RD</sup> LEVEL	258
254 <sup>TH</sup> LEVEL	259
255 <sup>TH</sup> LEVEL	260
256 <sup>TH</sup> LEVEL	261
257 <sup>TH</sup> LEVEL	262
258 <sup>TH</sup> LEVEL	263
259 <sup>TH</sup> LEVEL	264
260 <sup>TH</sup> LEVEL	265
261 <sup>ST</sup> LEVEL	266
262 <sup>ND</sup> LEVEL	267
263 <sup>RD</sup> LEVEL	268
264 <sup>TH</sup> LEVEL	269
265 <sup>TH</sup> LEVEL	270
266 <sup>TH</sup> LEVEL	271
267 <sup>TH</sup> LEVEL	272
268 <sup>TH</sup> LEVEL	273
269 <sup>TH</sup> LEVEL	274
270 <sup>TH</sup> LEVEL	275
271 <sup>ST</sup> LEVEL	276
272 <sup>ND</sup> LEVEL	277
273 <sup>RD</sup> LEVEL	278
274 <sup>TH</sup> LEVEL	279
275 <sup>TH</sup> LEVEL	280
276 <sup>TH</sup> LEVEL	281
277 <sup>TH</sup> LEVEL	282
278 <sup>TH</sup> LEVEL	283
279 <sup>TH</sup> LEVEL	284
280 <sup>TH</sup> LEVEL	285
281 <sup>ST</sup> LEVEL	286
282 <sup>ND</sup> LEVEL	287
283 <sup>RD</sup> LEVEL	288
284 <sup>TH</sup> LEVEL	289
285 <sup>TH</sup> LEVEL	290
286 <sup>TH</sup> LEVEL	291
287 <sup>TH</sup> LEVEL	292
288 <sup>TH</sup> LEVEL	293
289 <sup>TH</sup> LEVEL	294
290 <sup>TH</sup> LEVEL	295
291 <sup>ST</sup> LEVEL	296
292 <sup>ND</sup> LEVEL	297
293 <sup>RD</sup> LEVEL	298
294 <sup>TH</sup> LEVEL	299
295 <sup>TH</sup> LEVEL	300
296 <sup>TH</sup> LEVEL	301
297 <sup>TH</sup> LEVEL	302
298 <sup>TH</sup> LEVEL	303
299 <sup>TH</sup> LEVEL	304
300 <sup>TH</sup> LEVEL	305
301 <sup>ST</sup> LEVEL	306
302 <sup>ND</sup> LEVEL	307
303 <sup>RD</sup> LEVEL	308
304 <sup>TH</sup> LEVEL	309
305 <sup>TH</sup> LEVEL	310
306 <sup>TH</sup> LEVEL	311
307 <sup>TH</sup> LEVEL	312
308 <sup>TH</sup> LEVEL	313
309 <sup>TH</sup> LEVEL	314
310 <sup>TH</sup> LEVEL	315
311 <sup>ST</sup> LEVEL	316
312 <sup>ND</sup> LEVEL	317
313 <sup>RD</sup> LEVEL	318
314 <sup>TH</sup> LEVEL	319
315 <sup>TH</sup> LEVEL	320
316 <sup>TH</sup> LEVEL	321
317 <sup>TH</sup> LEVEL	322
318 <sup>TH</sup> LEVEL	323
319 <sup>TH</sup> LEVEL	324
320 <sup>TH</sup> LEVEL	325
321 <sup>ST</sup> LEVEL	326
322 <sup>ND</sup> LEVEL	327
323 <sup>RD</sup> LEVEL	328
324 <sup>TH</sup> LEVEL	329
325 <sup>TH</sup> LEVEL	330
326 <sup>TH</sup> LEVEL	331
327 <sup>TH</sup> LEVEL	332
328 <sup>TH</sup> LEVEL	333
329 <sup>TH</sup> LEVEL	334
330 <sup>TH</sup> LEVEL	335
331 <sup>ST</sup> LEVEL	336
332 <sup>ND</sup> LEVEL	337
333 <sup>RD</sup> LEVEL	338
334 <sup>TH</sup> LEVEL	339
335 <sup>TH</sup> LEVEL	340
336 <sup>TH</sup> LEVEL	341
337 <sup>TH</sup> LEVEL	342
338 <sup>TH</sup> LEVEL	343
339 <sup>TH</sup> LEVEL	344
340 <sup>TH</sup> LEVEL	345
341 <sup>ST</sup> LEVEL	346
342 <sup>ND</sup> LEVEL	347
343 <sup>RD</sup> LEVEL	348
344 <sup>TH</sup> LEVEL	349
345 <sup>TH</sup> LEVEL	350
346 <sup>TH</sup> LEVEL	351
347 <sup>TH</sup> LEVEL	352
348 <sup>TH</sup> LEVEL	353
349 <sup>TH</sup> LEVEL	354
350 <sup>TH</sup> LEVEL	355
351 <sup>ST</sup> LEVEL	356
352 <sup>ND</sup> LEVEL	357
353 <sup>RD</sup> LEVEL	358
354 <sup>TH</sup> LEVEL	359
355 <sup>TH</sup> LEVEL	360
356 <sup>TH</sup> LEVEL	361
357 <sup>TH</sup> LEVEL	362
358 <sup>TH</sup> LEVEL	363
359 <sup>TH</sup> LEVEL	364
360 <sup>TH</sup> LEVEL	365
361 <sup>ST</sup> LEVEL	366
362 <sup>ND</sup> LEVEL	367
363 <sup>RD</sup> LEVEL	368
364 <sup>TH</sup> LEVEL	369
365 <sup>TH</sup> LEVEL	370
366 <sup>TH</sup> LEVEL	371
367 <sup>TH</sup> LEVEL	372
368 <sup>TH</sup> LEVEL	373
369 <sup>TH</sup> LEVEL	374
370 <sup>TH</sup> LEVEL	375
371 <sup>ST</sup> LEVEL	376
372 <sup>ND</sup> LEVEL	377
373 <sup>RD</sup> LEVEL	378
374 <sup>TH</sup> LEVEL	379
375 <sup>TH</sup> LEVEL	380
376 <sup>TH</sup> LEVEL	381
377 <sup>TH</sup> LEVEL	382
378 <sup>TH</sup> LEVEL	383
379 <sup>TH</sup> LEVEL	384
380 <sup>TH</sup> LEVEL	385
381 <sup>ST</sup> LEVEL	386
382 <sup>ND</sup> LEVEL	387
383 <sup>RD</sup> LEVEL	388
384 <sup>TH</sup> LEVEL	389
385 <sup>TH</sup> LEVEL	390
386 <sup>TH</sup> LEVEL	391
387 <sup>TH</sup> LEVEL	392
388 <sup>TH</sup> LEVEL	393
389 <sup>TH</sup> LEVEL	394
390 <sup>TH</sup> LEVEL	395
391 <sup>ST</sup> LEVEL	396
392 <sup>ND</sup> LEVEL	397
393 <sup>RD</sup> LEVEL	398
394 <sup>TH</sup> LEVEL	399
395 <sup>TH</sup> LEVEL	400
396 <sup>TH</sup> LEVEL	401
397 <sup>TH</sup> LEVEL	402
398 <sup>TH</sup> LEVEL	403
399 <sup>TH</sup> LEVEL	404
400 <sup>TH</sup> LEVEL	405
401 <sup>ST</sup> LEVEL	406
402 <sup>ND</sup> LEVEL	407
403 <sup>RD</sup> LEVEL	408
404 <sup>TH</sup> LEVEL	409
405 <sup>TH</sup> LEVEL	410
406 <sup>TH</sup> LEVEL	411
407 <sup>TH</sup> LEVEL	412
408 <sup>TH</sup> LEVEL	413
409 <sup>TH</sup> LEVEL	414
410 <sup>TH</sup> LEVEL	415
411 <sup>ST</sup> LEVEL	416
412 <sup>ND</sup> LEVEL	417
413 <sup>RD</sup> LEVEL	418
414 <sup>TH</sup> LEVEL	419
415 <sup>TH</sup> LEVEL	420
416 <sup>TH</sup> LEVEL	421
417 <sup>TH</sup> LEVEL	422
418 <sup>TH</sup> LEVEL	423
419 <sup>TH</sup> LEVEL	424
420 <sup>TH</sup> LEVEL	425
421 <sup>ST</sup> LEVEL	426
422 <sup>ND</sup> LEVEL	427
423 <sup>RD</sup> LEVEL	428
424 <sup>TH</sup> LEVEL	429
425 <sup>TH</sup> LEVEL	430
426 <sup>TH</sup> LEVEL	431
427 <sup>TH</sup> LEVEL	432
428 <sup>TH</sup> LEVEL	433
429 <sup>TH</sup>	

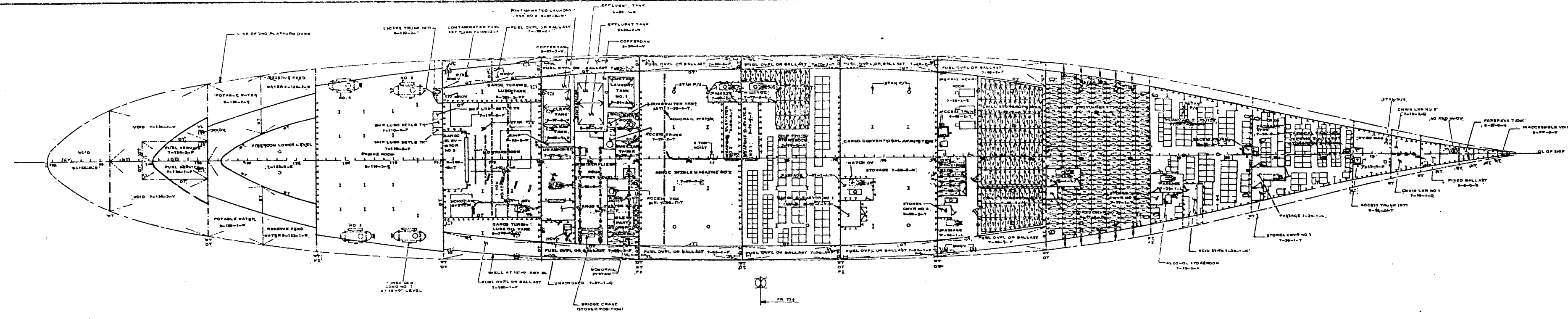

AD41-601-4860043  
THIRD PLATFORM  
SCALE 1/16"=1'-0"  
PLATE 14 OF 17

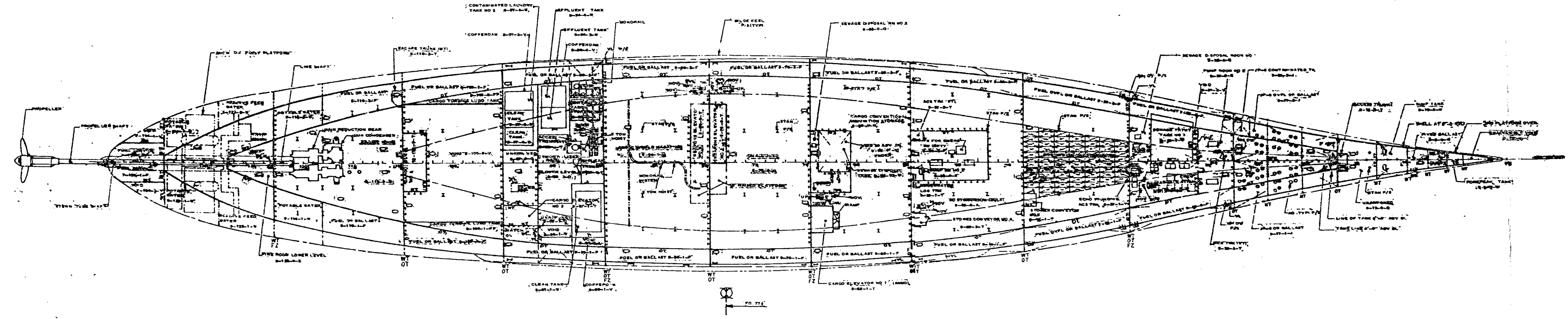

AD41-601-4860043  
HOLD  
SCALE 1/16"=1'-0"  
PLATE 15 OF 17

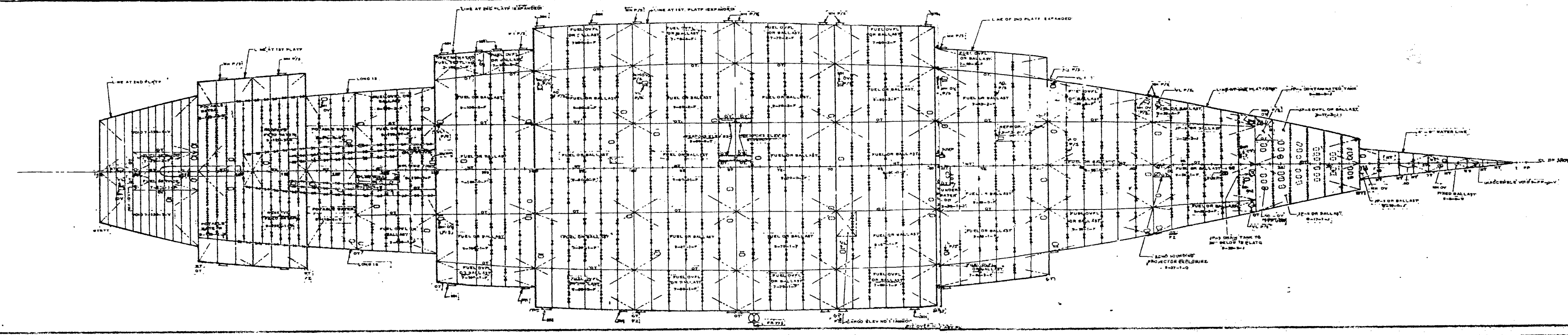

AD41-601-4860043  
INNER BOTTOM  
SCALE 1/16"=1'-0"  
PLATE 16 OF 17

NASSCO DWS NUMBER	411-800-021	NATIONAL STEEL & SHIPBUILDING CO.	SAN DIEGO, CALIFORNIA
CONTRACT EXAMINATION RECORD	DESTROYER TENDER AD-41 CLASS BOOKLET OF GENERAL PLANS		
DRAWN	J. HERNANDEZ	THIRD PLATFORM, HOLD, AND INNER BOTTOM	
CHECKED			
APPROVED DATE			
NATIONAL STEEL & SHIPBUILDING CO.	J 81220	601	4860043
SCALE	1/16"=1'-0"	AD-41	16 OF 17

4118000-64R1

4118000-64R2

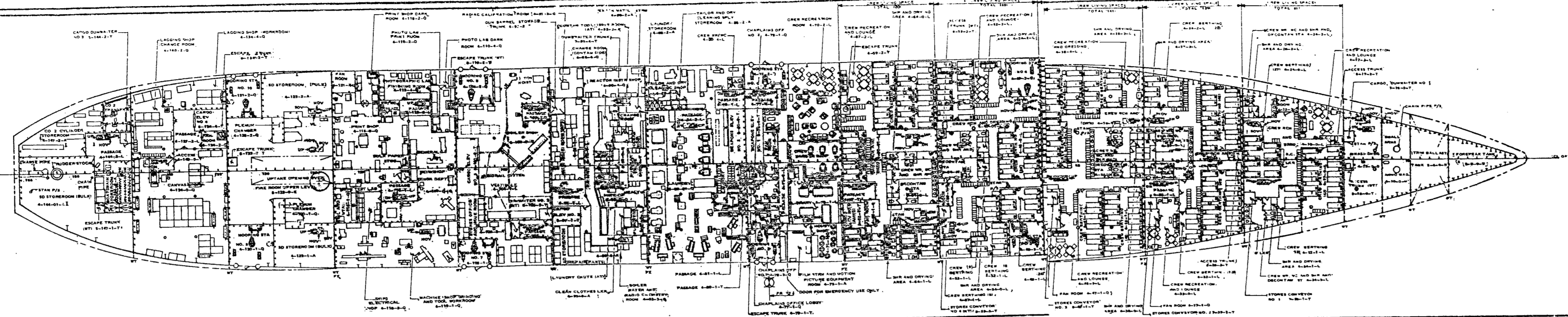

AD41-601-4860043  
4TH DECK  
SCALE 1/16"=1'-0"  
PLATE 11 OF 17

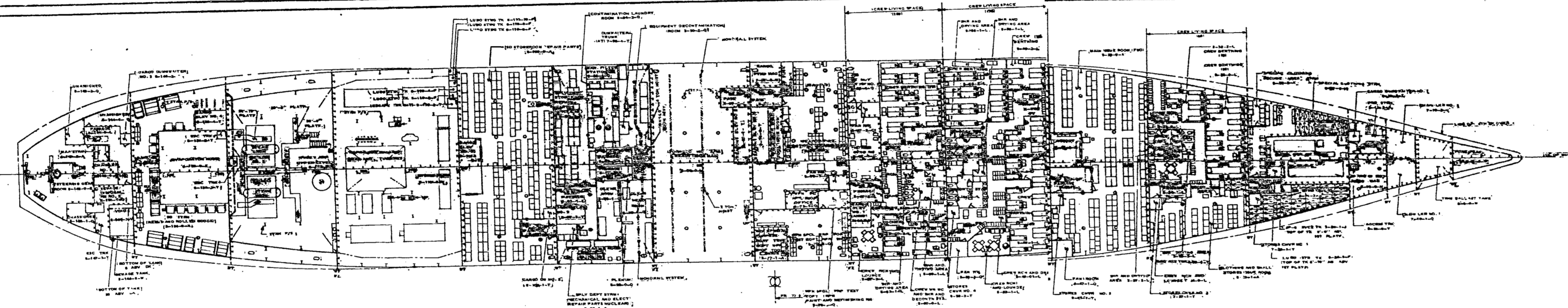

AD41-601-4860043  
FIRST PLATFORM  
SCALE 1/16"=1'-0"  
PLATE 12 OF 17

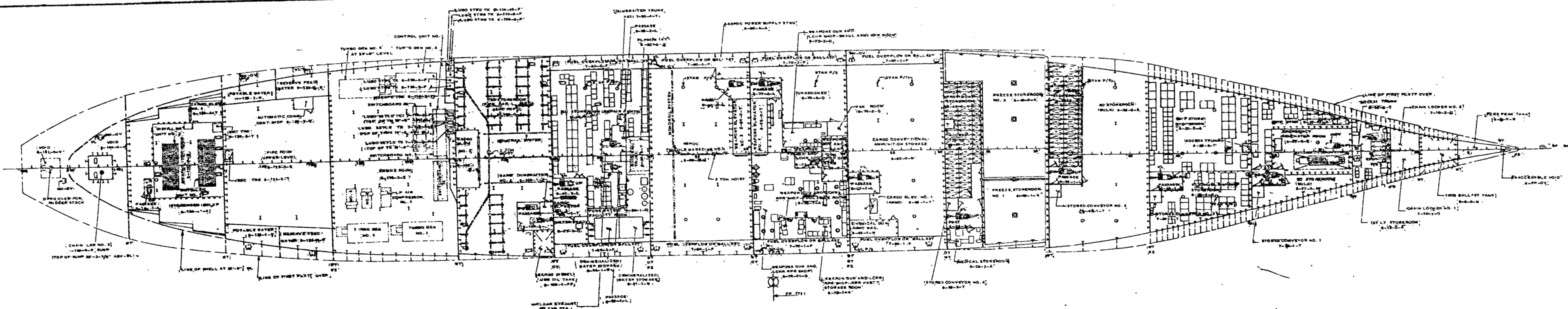

AD41-601-4860043  
SECOND PLATFORM  
SCALE 1/16"=1'-0"  
PLATE 13 OF 17

NASSCO DWG NUMBER	411-800-021	NATIONAL STEEL & SHIPBUILDING CO. SAN DIEGO, CALIFORNIA
CONTRACT	EXAMINATION RECORD	DESTROYER TENDER AD-41 CLASS BOOKLET OF GENERAL PLANS
DRAWN	DESIGNED	FOURTH DECK, FIRST AND SECOND PLATFORMS
APPROVED	DATE	
DATE	JUN 22 1961	601 4860043
SCALE	1/16"=1'-0"	AD-41 Sheet 5 of 6

41-8000-54R1

41-8000-54R2

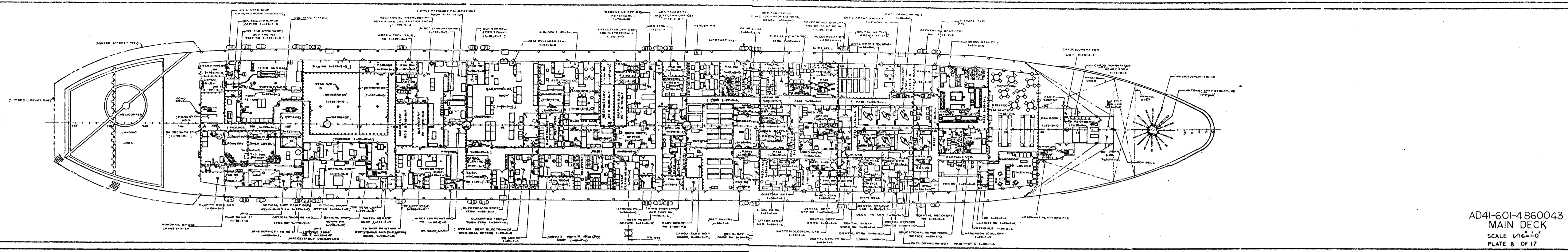

AD41-601-4860043  
 MAIN DECK  
 SCALE 1/16"=1'-0"  
 PLATE 8 OF 17

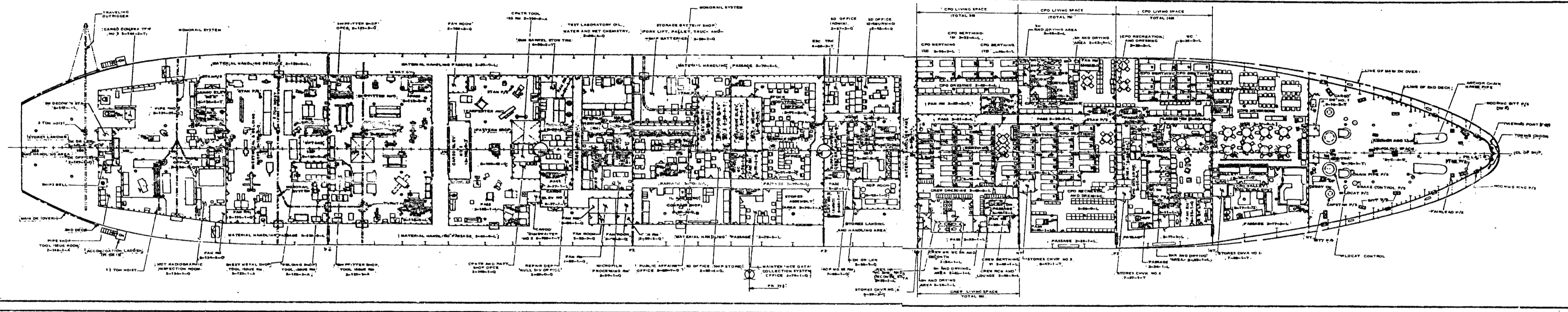

AD41-601-4860043  
 SECOND DECK  
 SCALE 1/16"=1'-0"  
 PLATE 9 OF 17

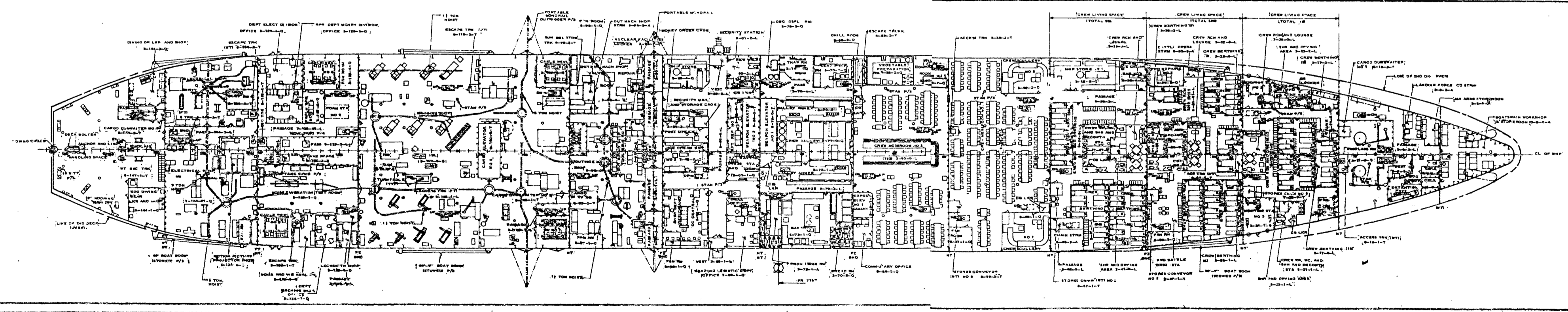

AD41-601-4860043  
 THIRD DECK  
 SCALE 1/16"=1'-0"  
 PLATE 10 OF 17

NASSCO DWG. NUMBER	411800021	NATIONAL STEEL & SHIPBUILDING CO. SAN DIEGO, CALIFORNIA
CONTRACT		DESTROYER TENDER AD-41 CLASS
EXAMINATION RECORD		BOOKLET OF GENERAL PLANS
DRAWN	J. HERNANDEZ	MAIN DECK, SECOND DECK, AND THIRD DECK
CHECKED		
APPROVED DATE		
NATIONAL STEEL & SHIPBUILDING CO.		
APPROVED DATE	J 81220	6014860043
DATE	10/17/54	AD-41

41800021/R1

41800021/R2

05 LEVEL  
32'-0" ABV O LEVEL

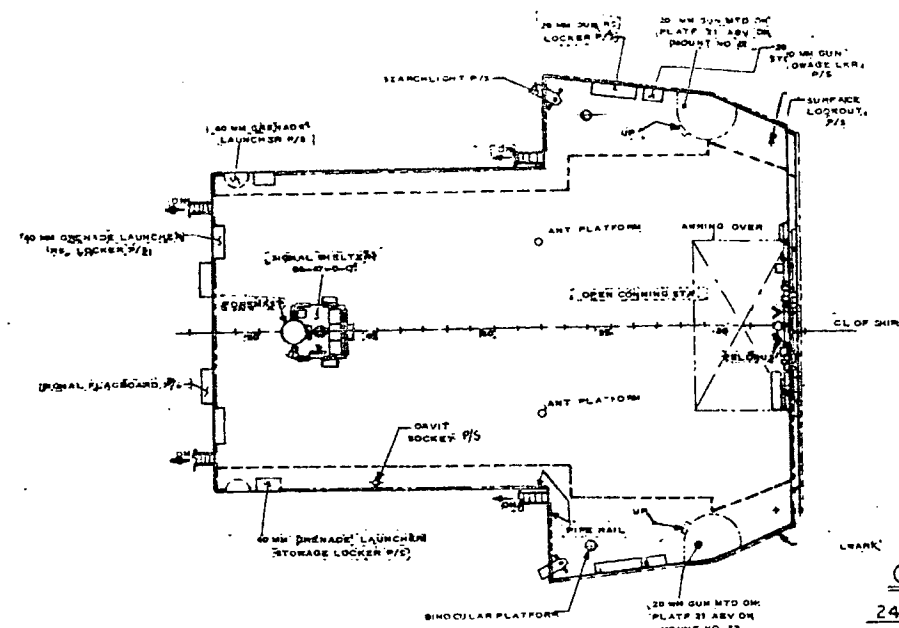

04 LEVEL  
24'-0" ABV O LEVEL

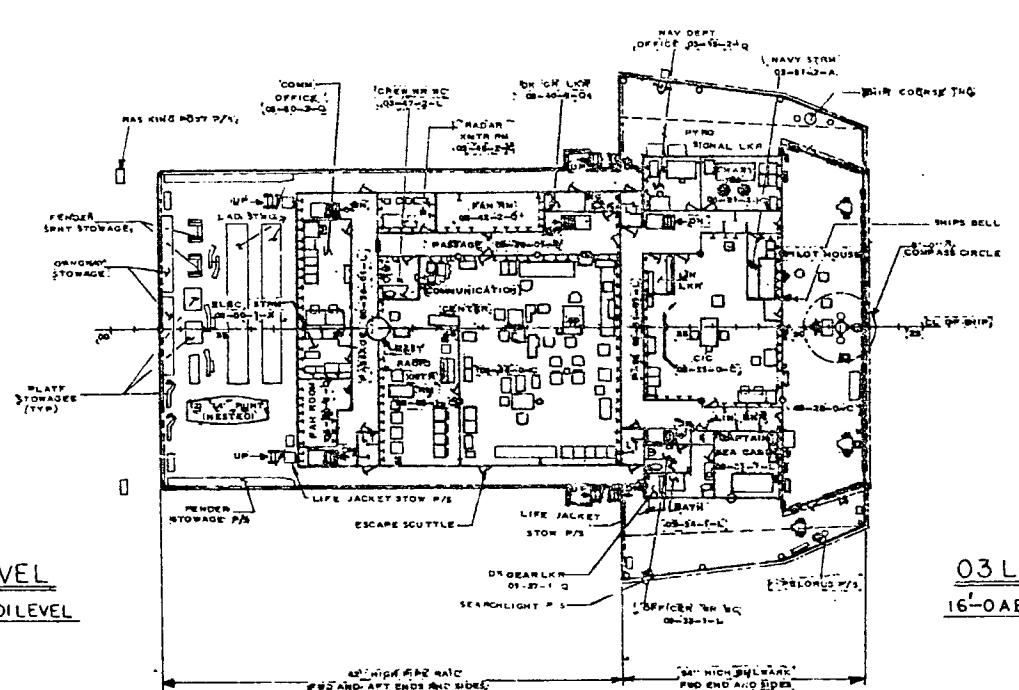

03 LEVEL  
16'-0" ABV O LEVEL

AD41-601-4860043  
03, 04, 05 LEVELS  
SCALE 1/16" = 1'-0"  
PLATE 5 OF 17

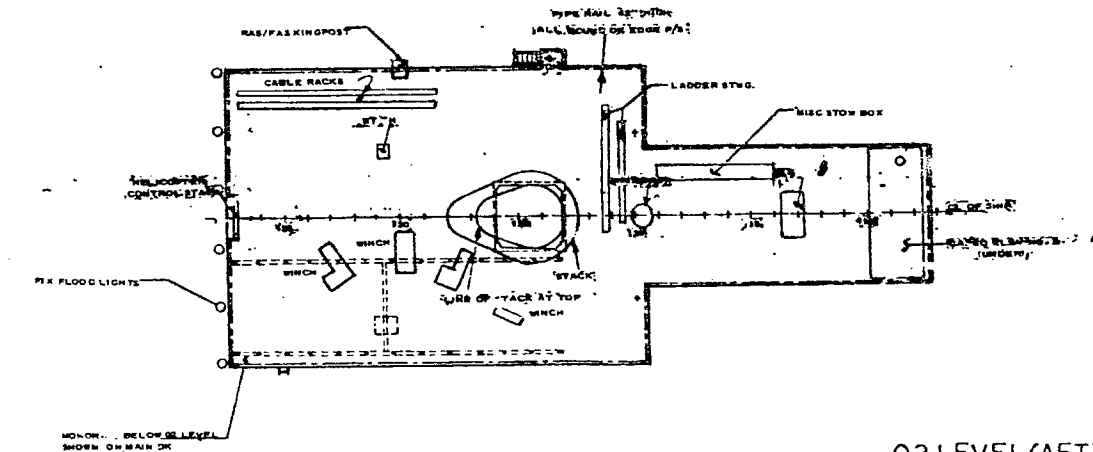

02 LEVEL (AFT)  
11'-0" ABV O LEVEL

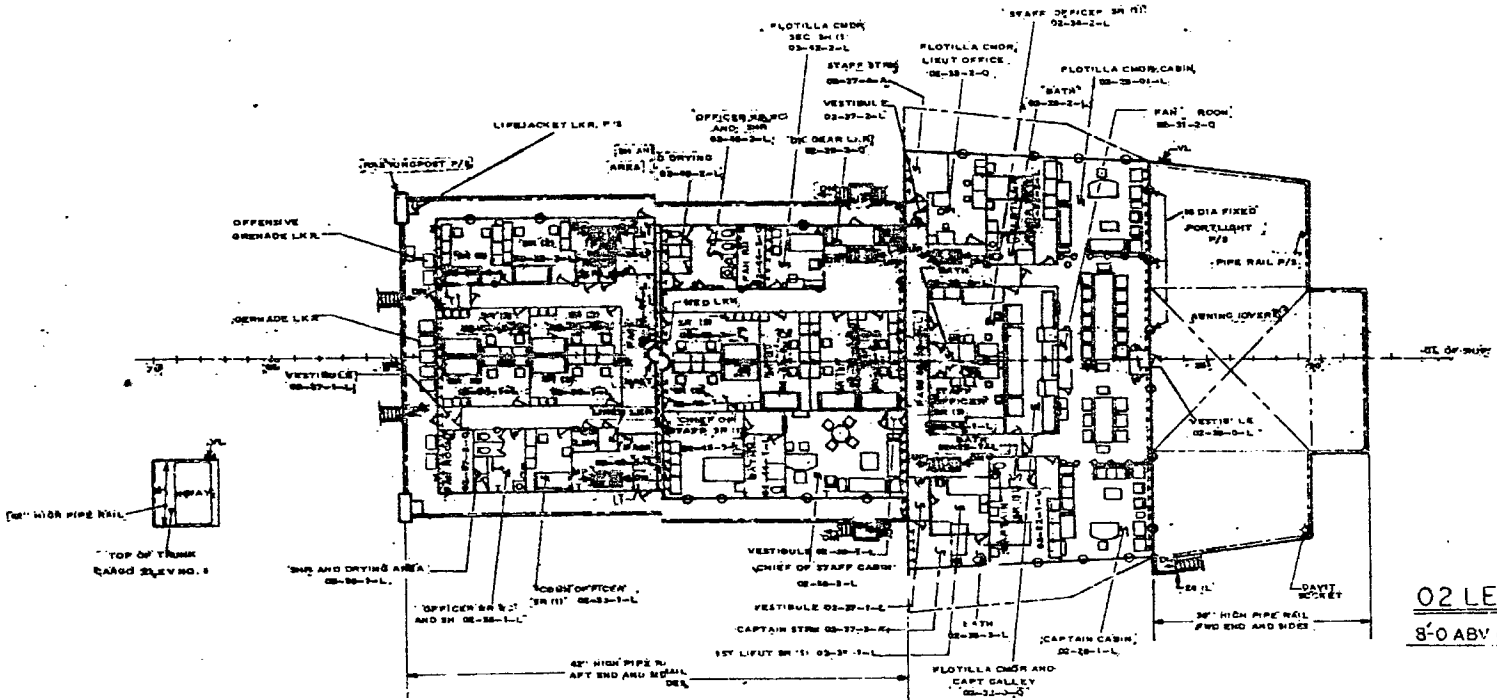

02 LEVEL  
8'-0" ABV O LEVEL

AD41-601-4860043  
02 LEVEL  
SCALE 1/16" = 1'-0"  
PLATE 6 OF 17

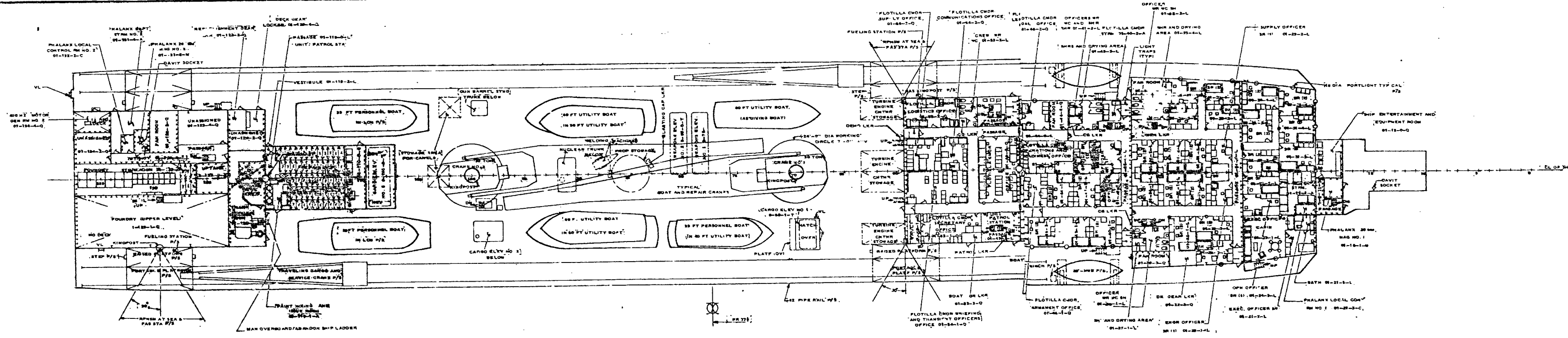

AD41-601-4860043  
01 LEVEL  
SCALE 1/16" = 1'-0"  
PLATE 7 OF 17

NASSCO DWG. NUMBER	411-800-021	NATIONAL STEEL & SHIPBUILDING CO. SAN DIEGO, CALIFORNIA
EXAMINATION RECORD	DESTROYER TENDER AD 41 CLASS BOOKLET OF GENERAL PLANS	
DESIGNED BY	03, 04, 05 LEVELS	
CHECKED	02 LEVEL AND O LEVEL	
APPROVED	DATE	
APPROVED	DATE	BY
	JUN 22 1961	14860043
DESIGNED BY	SAV 81220	SAV 81220
CHECKED BY	SAV 81220	SAV 81220
APPROVED BY	SAV 81220	SAV 81220

4180002-34R1

4180002-34R2

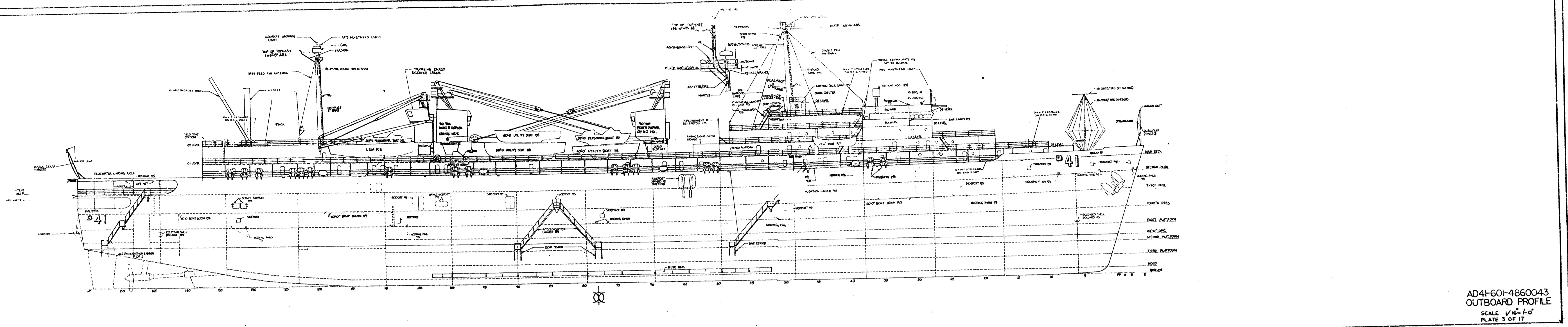

AD4-601-4860043  
OUTBOARD PROFILE  
SCALE 1/16" = 1'-0"  
PLATE 3 OF 17

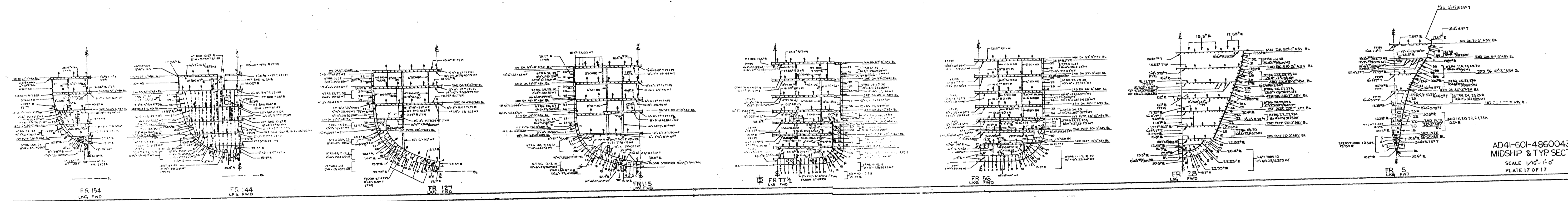

AD4-601-4860043  
MIDSHIP & TYP SECT  
SCALE 1/16" = 1'-0"  
PLATE 17 OF 17

NASSCO DWG. NUMBER	411-800-021	NATIONAL STEEL & SHIPBUILDING CO. SAN DIEGO, CALIFORNIA
EXAMINATION RECORD		DESTROYER TENDER AD-41 CLASS BOOKLET OF GENERAL PLANS OUTBOARD PROFILE AND MIDSHIP AND TYP SECT
DESIGNED BY	J. HEBANDEZ	
CHECKED		
APPROVED DATE		
APPROVED DATE	JUL 8 1952	601 4860043
SCALE	1/16" = 1'-0"	AD-41

411800021 27R1

411800021 27R2

